

RUB RAIL

Replacement Selection Guide



This guide cross-references the original factory rub rail used by over 80 of the leading boat manufacturers since 1993.

To find the rub rail you need, follow these easy steps:

- 1) Look up the make of boat
- 2) Match the rub rail and insert (*best if you have a sample*)
- 3) Choose the preferred color
- 4) Call a distributor or retailer to order

All TACO colors are UV stabilized to withstand the sun and sea. TACO's wide variety of colors allows you to accent traditional rub rails to fit your style.

**TACO makes choosing a
rub rail in the color
you want fast and easy.**

COLORS Vinyl Color Reference

BJA

Black

GRA

Medium Gray

GRS

Gray

WHA

Arctic White

WHC

Frosty White

WHD

Silver White

WHK

Pearl White

WHN

Cream

CP

Chrome

SS

Stainless Steel

**Due to the variation in the viewing and printing process, sizes and colors may vary slightly from the original product.*

Boat Builders Index

Action Craft1	Fountain Powerboats 3	Sailfish Boats5
Alden Yachts1	Four Winns3	Scout5
Angler1	Gamble3	Sea Ray5
Aquasport1	Glacier Bay3	Sea Swirl5
Astro Boats1	Glastron/Larson3	Seabring5
Baja Boats1	Grady White3	Shearwater5
Bayliner1	Hunter Marine3	Silverton5
Bertram1	Hydrasports3	Southwind5
Bombardier1	Key West Boats3	Sport Craft5
Boston Whaler1	Larson Boats3	Starcraft5
Carolina Skiff1	Lowe Boats3	Stingray5
Century2	Luhrs4	Stratos Boats6
Chapparral2	Mainship4	Tahoe Boats6
Chris Craft2	Mako4	Tennessee Watercraft .6
Cobalt2	Mariah4	Thunderbird6
Cobia2	Mastercraft4	Tiara6
Contender2	Maverick Boats4	Tige6
Correct Craft2	Maxum4	Triton Boats6
Crestliner2	Monterey4	Triumph Boats6
Donzi2	Pro-Line4	Trophy6
Doral2	Pro-Sport Boats4	Wellcraft6
Dusky2	Pursuit4	World Class Catamarans 6
Ebbtide Boats2	Regal Marine5	Yamaha6
Everglades Boats2	Rinker5	
Formula2	Robalo5	



Rub Rail and color samples are available upon request.

Boat Builders

Rub Rail	Page	Insert	Page
Action Craft			
V11-3447	11	V12-0003	26
V11-4014	11	5/8" Rope Stiffener: A40-0812	26
V21-9517	17	V12-0303	26
Alden Yachts			
S11-451S	23	N/A	N/A
S11-4650	25	N/A	N/A
S11-467S	23	N/A	N/A
Angler			
V11-0809	9	V12-0005	26
V11-2423	10	V12-0003	26
V11-4135	12	N/A	N/A
V21-9501	17	V12-0303	26
Aquasport			
V11-2423	10	V12-0003	26
V21-9501	17	V12-0303	26
Astro Boats			
V21-9678	20	V12-4144	28
Baja Boats			
V21-9517	17	V12-0303	26
Bayliner			
A11-0342	7	V12-0342	28
A11-0347	8	V12-4155	28
A12-0303	9	V12-0303	26
A12-0305	9	V12-0303	26
V11-2423	10	V12-0303	26
V21-0188	13	N/A	N/A
V21-3670	16	N/A	N/A
V21-9501	17	V12-0303	26
V21-9678	20	V12-4144	28
Bertram			
A11-0511	8	N/A	N/A
Bombardier			
V21-9501	17	V12-0303	26
Boston Whaler			
A11-0347	8	V12-4155	28
V11-0899	10	V12-0005	26
V11-2423	10	V12-0003	26
V21-9678	20	V12-4144	28
Carolina Skiff			
V21-9659	21	S11-4511	27
V21-9662	21	V12-1069	30

Rub Rail	Page	Insert	Page
Century			
A11-0638	10	V12-0338	27
S11-4670	27	N/A	N/A
V21-9501	19	V12-0303	26
V21-9678	22	V12-4144	28
Chapparral Boats			
A11-0638	8	V12-0338	27
V21-9659	19	S11-4511	25
V21-9678	20	V12-4144	28
Chris Craft Boats			
A11-0152	7	N/A	N/A
V11-9669	12	S11-4690	25
V21-9659	19	S11-4511	25
Cobalt Boats			
V11-9669	12	S11-4690	25
Cobia			
A11-0638	8	V12-0338	27
S11-4670	25	N/A	N/A
V21-9501	17	V12-0303	26
V21-9678	20	V12-4144	28
Contender			
V11-2423	10	V12-0003	26
V21-3670	16	N/A	N/A
V21-9501	17	V12-0303	26
V21-9517	17	V12-0303	26
V21-9602	18	V12-0303	26
Correct Craft			
A11-0152	7	N/A	N/A
V11-3447	11	V12-0003	26
V21-0460	14	N/A	N/A
Crestliner			
V11-3447	11	V12-0003	26
V21-9501	17	V12-0303	26
Donzi			
A11-0152	7	N/A	N/A
V11-9669	12	S11-4690	25
V21-9602	18	V12-0303	26
Doral			
V21-0188	13	S11-4511	25
Dusky			
V11-2423	10	V12-0003	26
Ebbtide Boats			
V21-9678	20	V12-4144	28
Everglades Boats			
V21-9502	17	S11-4650	25
V21-9678	20	V12-4144	28
Formula			
V21-1025	15	S11-4511	25
V21-3671	16	N/A	N/A
V21-9602	18	V12-0303	26

Rub Rail	Page	Insert	Page
Fountain Powerboats			
A11-0152	7	N/A	N/A
A11-0342	7	V12-0342	28
V21-3670	16	N/A	N/A
V21-9602	18	V12-0303	26
V21-9648	19	S11-4511	25
V21-9679	20	S11-4511 or S11-4650	25
Four Winns			
A11-0638	8	V12-0338	27
V21-1025	15	S11-4511	25
V21-9501	17	V12-0303	26
V21-9517	17	V12-0303	26
V21-9659	19	S11-4511	25
V21-9662	19	V12-1069	28
V21-9811	22	V12-9809	29
Gambler			
V21-9722	21	S11-4511	25
Glacier Bay Catamarans			
V11-0809	9	V12-0810	28
V21-9501	17	V12-0303	26
V21-9659	19	S11-4511	25
Glastron/Larson			
A11-0638	8	V12-0338	27
A12-0303	9	V12-0303	26
V21-9501	17	V12-0303	26
V21-9659	19	S11-4511	25
V21-9662	19	V12-1069	28
Grady White			
A11-0151	7	N/A	N/A
V11-2423	10	V12-0003	26
V21-9866	22	S11-4511	25
Hunter Marine			
V11-0809	9	V12-0810	28
V11-3161	10	V22-3162	29
V11-9795	12	V12-4144	28
V21-9647	18	S11-4511	25
Hydrasports			
V11-4014	11	V12-0003	26
V21-3670	16	N/A	N/A
Key West Boats			
V11-4014	11	V12-0003	26
V21-9659	19	S11-4511	25
V21-9662	19	V12-1069	28
Larson Boats			
V21-9501	17	V12-0303	26
V21-9662	19	V12-1069	28
Lowe Boats			
V21-9602	18	V12-0303	26

Rub Rail	Page	Insert	Page
Luhrs			
A11-0151	7	N/A	N/A
A11-0152	7	N/A	N/A
S11-451S	23	N/A	N/A
S11-465S	23	N/A	N/A
V21-9647	18	S11-4511	25
Mainship			
S11-465S	23	N/A	N/A
V21-9647	18	S11-4511	25
Mako			
V11-0899	10	V12-0005	26
V11-2423	10	V12-0003	26
V21-9517	17	V12-0303	26
Mariah Boats			
A11-0638	8	V12-0338	27
V21-9501	17	V12-0303	26
Mastercraft Boats			
A11-0151	7	N/A	N/A
V21-9517	17	V12-0003	26
V21-9648	19	S11-4511	25
Maverick Boat Company			
V21-9501	17	V12-0303	26
Maxum			
A11-0342	7	V12-0342	28
A11-0347	8	V12-4155	28
A12-0303	9	V12-0303	26
A12-0305	9	V12-0303	26
V11-2423	10	V12-0003	26
V21-0188	13	N/A	N/A
V21-3670	16	N/A	N/A
V21-9501	17	V12-0303	26
Monterey			
V21-9659	19	S11-4511	25
V21-9811	22	S11-4511	25
Pro-Line Boats			
A11-0152	7	N/A	N/A
V11-9669	12	S11-4690	25
V21-3670	14	N/A	N/A
V21-9602	18	V12-0303	26
V21-9678	20	V12-4144	28
Pro Sport Boats			
V21-9662	19	V12-1069	28
Pursuit			
A11-0152	7	N/A	N/A
V21-9722	21	S11-4511	25
V21-9790	21	S11-4650	25
V21-9866	22	S11-4511	25

Rub Rail	Page	Insert	Page
Regal Marine			
A11-0152	7	N/A	N/A
V11-2423	10	V12-0003	26
V21-1025	15	S11-4511	25
V21-9501	17	V12-0307	27
V21-9502	17	S11-4650	25
Rinker			
V21-9659	19	S11-4511	25
Robalo			
V11-2423	10	V12-0003	26
V21-9678	20	V12-4144	28
Sailfish Boats			
V21-9501	17	V12-0303	26
V21-9648	19	S11-4511	25
V21-9659	19	S11-4511	25
V21-9678	20	V12-4144	28
V21-9679	20	S11-4511 or S11-4650	25
Scout			
V11-2423	10	V12-0003	26
V11-3447	11	V12-0003	26
Sea Ray Boats			
V11-3447	11	V12-0003	26
V21-0188	13	N/A	N/A
V21-1025	15	S11-4511	25
V21-9501	17	V12-0303	26
V21-9517	17	V12-0003	26
V21-9526	18	S11-465S	23
V21-9648	19	S11-4511	25
V21-9667	20	S11-4690	25
V21-9679	20	S11-4511	25
Sea Swirl			
V21-9501	17	V12-0303	26
Seabring Marine Industries			
V21-9501	17	V12-0303	26
V21-9679	20	S11-4511 or S11-4650	25
Shearwater			
V21-9722	21	S11-4511	25
Silverton			
V21-9648	19	S11-4511	25
Southwind			
V21-9659	19	S11-4511	25
V21-9678	20	V12-4144	28
Sport Craft			
A11-0342	7	V12-0342	28
V21-9501	17	V12-0303	26
V21-9602	17	V12-0303	26
Starcraft			
V21-9678	20	V12-4144	28
Stingray			
V21-9659	19	S11-4511	25

Rub Rail	Page	Insert	Page
Stratos Boats			
V21-9659	19	S11-4511	25
Tahoe Boats			
A12-0303	9	V12-0303	26
V21-9501	17	V12-0303	26
Tennessee Watercraft			
V21-9517	17	V12-0303	26
Thunderbird			
A11-0151	7	N/A	N/A
V21-1025	15	S11-4511	25
V21-9602	18	V12-0303	26
Tiara			
V11-2423	10	V12-0003	26
V21-1039	15	S11-4650	25
Tige Boats, Inc			
V21-9811	22	V12-9809	29
Triton Boats			
V11-9795	12	V12-4144	28
V21-9790	21	V12-0303	26
Triumph Boats			
V21-9662	19	V12-1069	28
Trophy			
A11-0342	7	V12-0342	28
A11-0347	8	V12-4155	28
A12-0303	9	V12-0303	26
A12-0305	9	V12-0303	26
V11-2423	10	V12-0003	26
V21-0188	13	N/A	N/A
V21-3670	16	N/A	N/A
V21-9501	17	V12-0303	26
V21-9678	20	V12-4144	28
Wellcraft Marine			
A11-0317	7	V12-0317	27
V11-0899	10	V12-0005	26
V21-1025	15	S11-4511	25
V21-3670	16	N/A	N/A
V21-3671	16	N/A	N/A
V21-9501	17	V12-0303	26
V21-9602	18	V12-0303	26
V21-9647	18	S11-4511	25
V21-9659	19	S11-4511	25
V21-9678	20	V12-4144	28
World Class Catamarans			
V21-9659	19	S11-4511	25
V21-9662	19	V12-1069	28
Yamaha			
V21-9659	19	S11-4511	25

Factory Rub Rail Replacement Reference Guide

GUIDE

A11-0151

Material: Anodized Aluminum
No Insert

Part Number	Finish	Length
A11-0151TAL12D	Anodized	12'

Drilled and countersunk for #8 screws on 6" centers

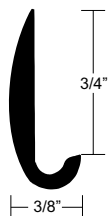

A11-0152

Material: Anodized Aluminum
No Insert

Part Number	Finish	Length
A11-0152TAL12D-A	Polished Clear	12'

Drilled and countersunk for #8 screws on 6" centers



A11-0317

Material: Anodized Aluminum
Insert: V12-0317

Part Number	Finish	Length
A11-0317TAL12D	Polished Clear	12'

Drilled and countersunk for #8 screws on 6" centers

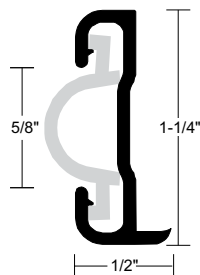

A11-0342

Material: Anodized Aluminum
Insert: V12-0342

Part Number	Finish	Length
A11-0342BLY12D	Polished Clear	12'

Drilled and countersunk for #8 screws on 6" centers

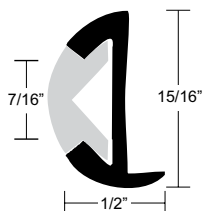

A11-0347

Material: Anodized Aluminum
Insert: V12-4155

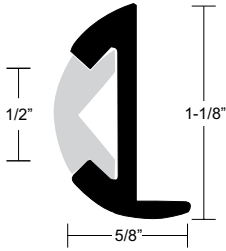

Part Number	Finish	Length
A11-0347BLY12D	Brite	12'

Drilled and countersunk for #8 screws on 6" centers

A11-0511

Material: Anodized Aluminum
No Insert

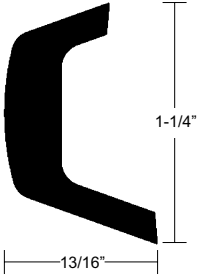

Part Number	Finish	Length
A11-0511TAL20D	Polished Clear	20'

Drilled and countersunk for #10 screws on 6" centers

A11-0514

Material: Anodized Aluminum
No Insert

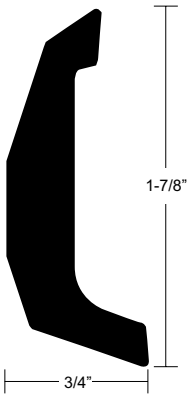

Part Number	Finish	Length
A11-0514TAL20D	Polished Clear	20'

Drilled and countersunk for #10 screws on 6" centers

A11-0638

Material: Anodized Aluminum
Insert: V12-0338

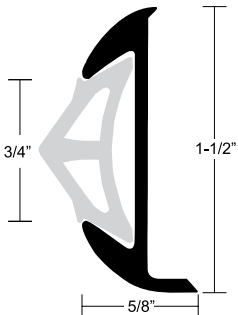

Part Number	Finish	Length
A11-0638TAL12D	Polished Clear	12'

Drilled and countersunk for #8 screws on 6" centers

A12-0303

Material: Anodized Aluminum
Insert: V12-0303

Part Number	Finish	Length
A12-0303BLY12D	Brite	12'

Drilled and countersunk for #10 screws on 6" centers

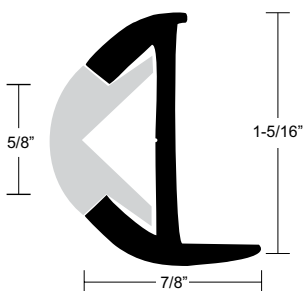

A12-0305

Material: Anodized Aluminum
Insert: V12-0303

Part Number	Finish	Length
A12-0305BLY12D	Brite	12'

Drilled and countersunk for #10 screws on 6" centers

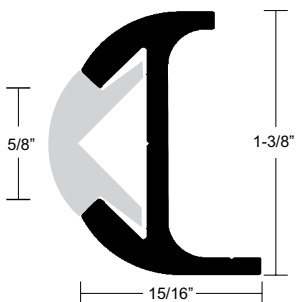

V11-0809

Material: Flexible Vinyl
Insert: V12-0810

Part Number	Color	Length
V11-0809BKA50-1	Black	50'
V11-0809BBK50-2*	Black/Black	50'
V11-0809BBK70-2*	Black/Black	70'
V11-0809BWK50-2*	Black/Arctic White	50'

*Inserts and screws are sold separately. *Complete kits available.*

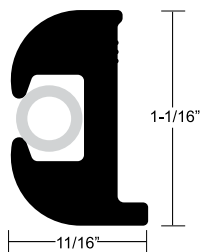

V11-0899

Material: Flexible Vinyl
Insert: V12-0005

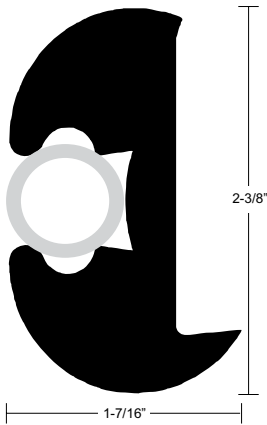

Part Number	Color	Length
V11-0899BKA100	Black	100'
V11-0899BBK100-2*	Black/Black	100'

Inserts and screws are sold separately. *Complete kits available.

V11-2423

Material: Flexible Vinyl
Insert: V12-0003

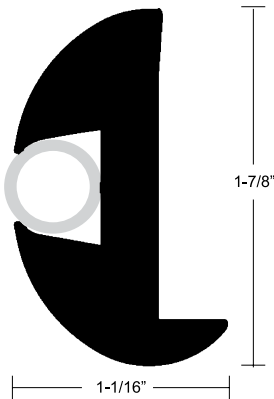

Part Number	Color	Length
V11-2423BKA50-1	Black	50'
V11-2423BKA70-1	Black	70'
V11-2423BKA100-1	Black	100'
V11-2423BBK50-2*	Black/Black	50'
V11-2423BBK70-2*	Black/Black	70'
V11-2423BWK50-2*	Black/Arctic White	50'
V11-2423BWK70-2*	Black/Arctic White	70'

Inserts, end caps and screws are sold separately. *Complete kits available.

V11-3161

Material: Flexible Vinyl
Insert: V22-3162

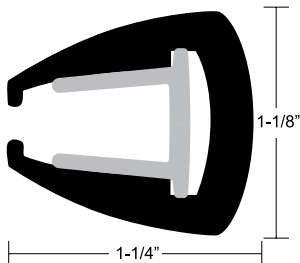

Part Number	Color	Length
V11-3161BKA50-1	Black	50'

Inserts, end caps and screws are sold separately.

V11-3426

Material: Flexible Vinyl

Insert: V12-0005

Part Number	Color	Length
V11-3426BKA50-1	Black	50'
V11-3426BKA70-1	Black	70'
V11-3426BBK50-2*	Black/Black	50'
V11-3426BBK70-2*	Black/Black	70'
V11-3426BWK50-2*	Black/Arctic White	50'
V11-3426BWK70-2*	Black/Arctic White	70'

*Complete kits available.

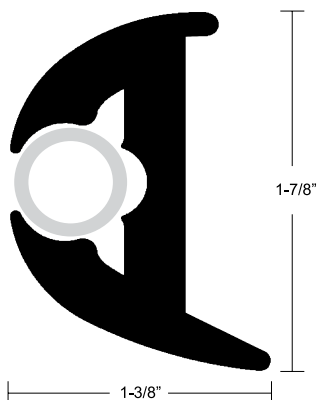

V11-3447

Material: Flexible Vinyl

Insert: V12-0003

Part Number	Color	Length
V11-3447BKA50-1	Black	50'
V11-3447BKA100-1	Black	100'
V11-3447BBK50-2*	Black/Black	50'
V11-3447BBK70-2*	Black/Black	70'
V11-3447BWK50-2*	Black/Arctic White	50'
V11-3447WWWK50-2*	Arctic White/Arctic White	50'

Inserts, end caps and screws are sold separately. *Complete kits available.

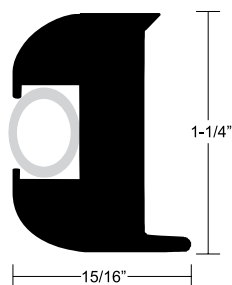

V11-4014

Material: Flexible Vinyl

Insert: V12-0003

Hull Stiffener: A40-0812

Part Number	Color	Length
V11-4014BKA70	Black	70'

Vinyl inserts sold separately in various colors and lengths

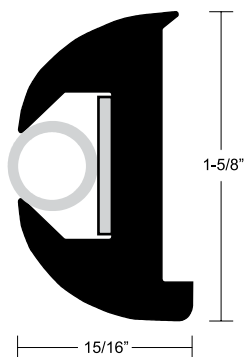

V11-4135

Material: Semi-Rigid Vinyl
No Insert

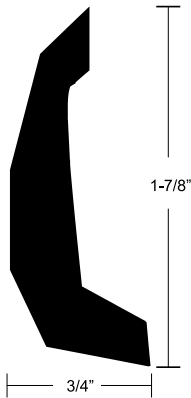

Part Number	Color	Length
V11-4135BKA30-3	Black	30'

V11-9669

Material: Semi-Rigid Vinyl
Insert: S11-4690

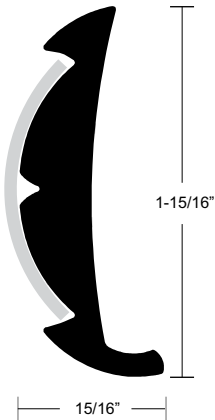

Part Number	Color	Length
V11-9669WHA100	Arctic White	100'

V11-9795

Material: Semi-Rigid Vinyl
Insert: V12-4144

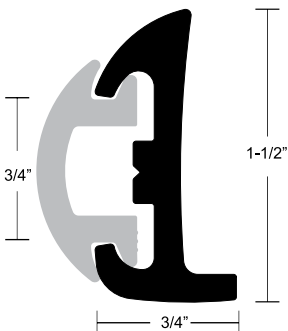

Part Number	Color	Length
V11-9795BKA50D-1	Black	50'
V11-9795BBK50D-2*	Black/Black	50'

*Inserts and end caps are sold separately. *Complete kits available.*

V21-0188

Material: Rigid Vinyl
No Insert

Part Number	Color	Length
V21-0188BKA20D	Black	20'

Drilled and countersunk for #8 screws on 6" centers

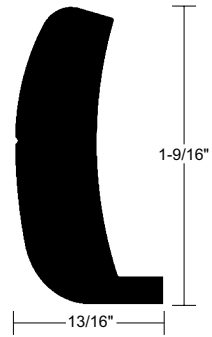

V21-0205

Material: Rigid Vinyl
No Insert

Part Number	Color	Length
V21-0205BKA20D	Black	20'

Drilled and countersunk for #10 screws on 6" centers

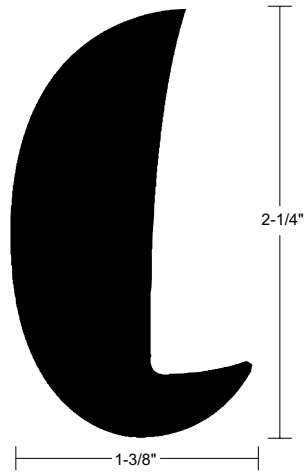

V21-0456

Material: Rigid Vinyl
No Insert

Part Number	Color	Length
V21-0456BKA12D	Black	12'

Drilled and countersunk for #8 screws on 6" centers

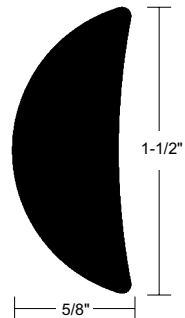

V21-0457

Material: Rigid Vinyl
No Insert

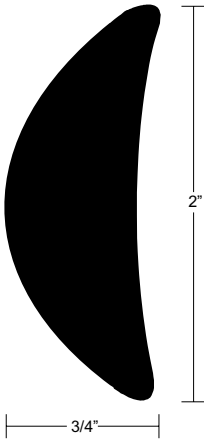

Part Number	Color	Length
V21-0457BKA20D	Black	20'

Drilled and countersunk for #8 screws on 6" centers

V21-0458

Material: Rigid Vinyl
No Insert

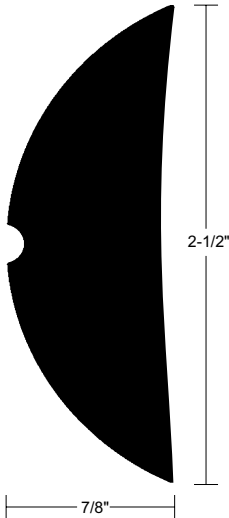

Part Number	Color	Length
V21-0458BKA20D	Black	20'

Drilled and countersunk for #10 screws on 6" centers

V21-0460

Material: Rigid Vinyl
No Insert

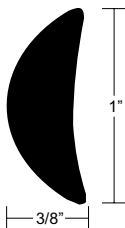

Part Number	Color	Length
V21-0460BKA12D	Black	12'

Drilled and countersunk for #6 screws on 6" centers

V21-0874

Spray Rail
Material: Rigid Vinyl

Part Number	Color	Length
V21-0874WHA18	Arctic White	18'

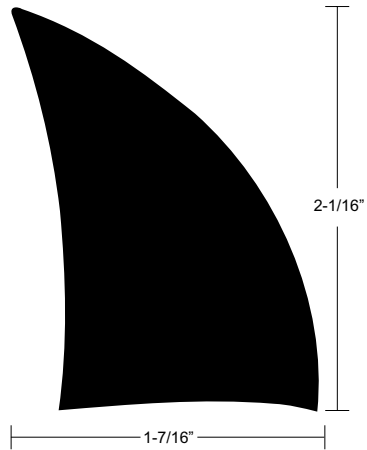

V21-1025

Material: Rigid Vinyl
Insert: S11-4511

Part Number	Color	Length
V21-1025WHC20D	Frosty White	20'

Drilled and countersunk for #10 screws on 6" centers

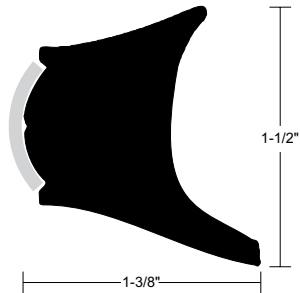

V21-1039

Material: Rigid Vinyl
Insert: S11-4650

Part Number	Color	Length
V21-1039BKA20D1	Black	20'

Drilled and countersunk for #8 screws on 12" centers

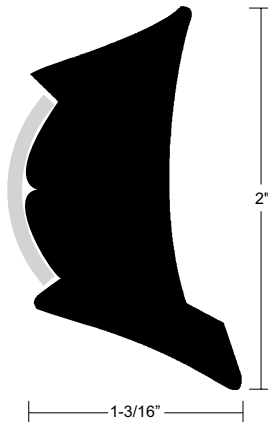

V21-3670

Material: Rigid Vinyl
No Insert

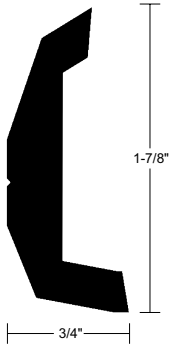

Part Number	Color	Length
V21-3670BKA20D	Black	20'
V21-3670WHA20D	Arctic White	20'

Drilled and countersunk for #10 screws on 8" centers

V21-3671

Material: Rigid Vinyl
No Insert

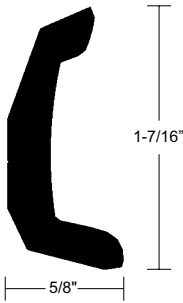

Part Number	Color	Length
V21-3671BKA20D2	Black	20'
V21-3671WHA20D2	Arctic White	20'

Drilled and countersunk for #10 screws on 8" centers

V21-9140

Canoe Rail
Material: Rigid Vinyl

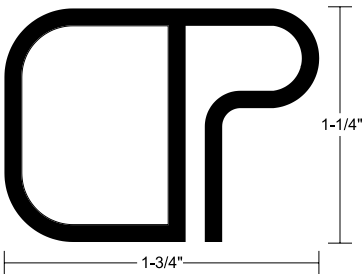

Part Number	Color	Length
V21-9140BKA166	Black	16'6"

V21-9501

Material: Rigid Vinyl

Insert: V12-0303

Part Number	Color	Length
V21-9501WHC20D	Frosty White	20'

Drilled and countersunk for #10 screws on 6" centers

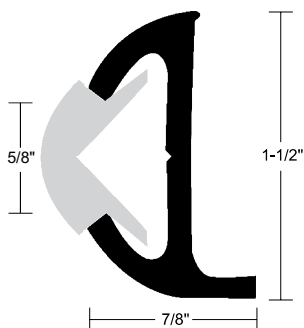

V21-9502

Material: Rigid Vinyl

Insert: S11-4650

Part Number	Color	Length
V21-9502BKA20D*	Black	20'
V21-9502WHC20DV05*	Frosty White	20'

•Drilled and countersunk for #8 screws on 6" centers
•Drilled and countersunk for #10 screws on 6" centers

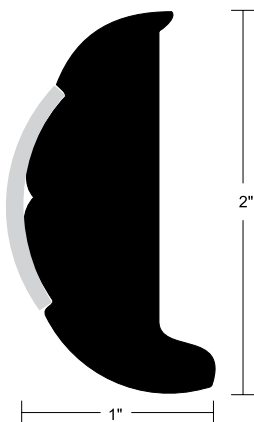

V21-9517

Material: Rigid Vinyl

Insert: V12-0303

Part Number	Color	Length
V21-9517BKA20D	Black	20'

Drilled for #10 screws on 6" centers

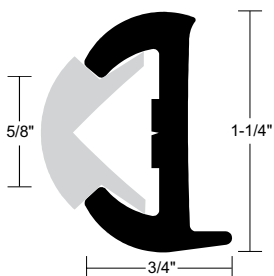

V21-9526

Material: Rigid Vinyl
Insert: S11-465S

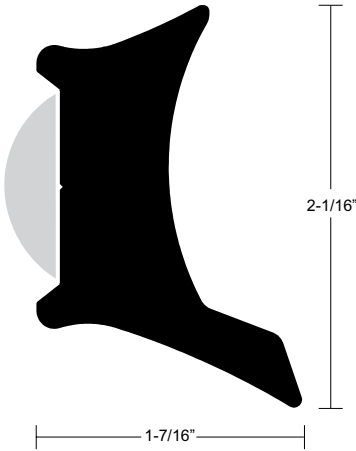

Part Number	Color	Length
V21-9526WHC20D	Frosty White	20'

Drilled and countersunk for #12 screws on 6" centers

V21-9602

Material: Rigid Vinyl
Insert: V12-0303

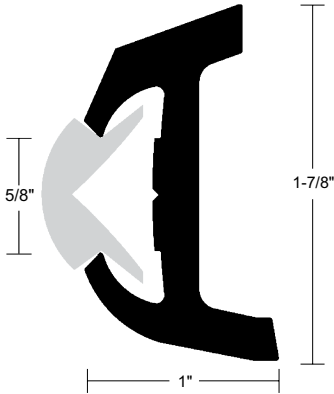

Part Number	Color	Length
V21-9602WHA20D	Arctic White	20'

Drilled and countersunk for #10 screws on 8" centers

V21-9647

Material: Rigid Vinyl
Insert: S11-4511

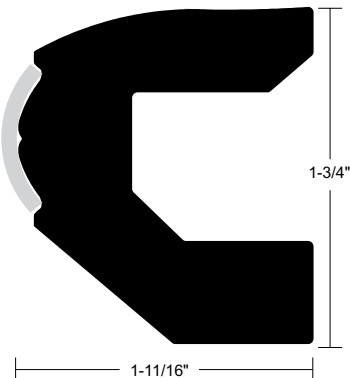

Part Number	Color	Length
V21-9647WHA20D	Arctic White	20'

Drilled and countersunk for #10 screws on 12" centers

V21-9648

Material: Rigid Vinyl
Insert: S11-4511

Part Number	Color	Length
V21-9648WHC20D	Frosty White	20'

Drilled and countersunk for #8 screws on 8" centers

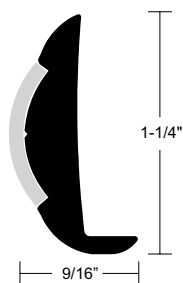

V21-9659

Material: Rigid Vinyl
Insert: S11-4511

Part Number	Color	Length
V21-9659BKA20D	Black	20'

Drilled and countersunk for #8 screws on 8" centers

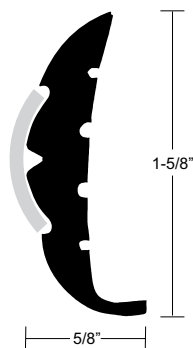

V21-9662

Material: Rigid Vinyl
Insert: V12-1069

V21-9662BKA20D	Black	20'
V21-9662WHC20D	Frosty White	20'

Drilled and countersunk for #8 screws on 8" centers

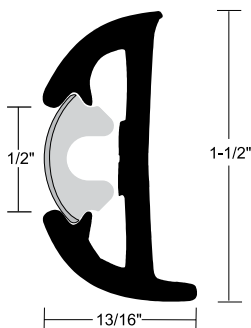

V21-9667

Material: Rigid Vinyl
Insert: S11-4690

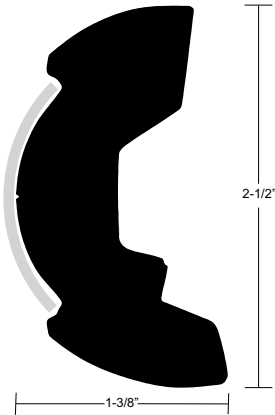

Part Number	Color	Length
V21-9667WHC20D	Frosty White	20'

Drilled and countersunk for #10 screws on 6" centers

V21-9678

Material: Rigid Vinyl
Insert: V12-4144

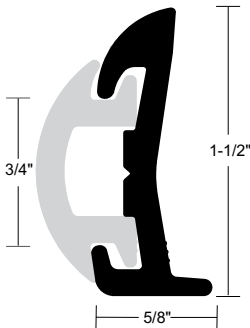

Part Number	Color	Length
V21-9678BKA20D	Black	20'
V21-9678WHA20D	Arctic White	20'

Drilled and countersunk for #8 screws on 6" centers

V21-9679

Material: Rigid Vinyl
Insert: S11-4511



Part Number	Color	Length
V21-9679BKA20D	Black	20'
V21-9679WHC20D	Frosty White	20'

Drilled and countersunk for #8 screws on 8" centers

V21-9692

Material: Rigid Vinyl
Insert: V12-4153

Part Number	Color	Length
V21-9692WHN20D	Black	20'

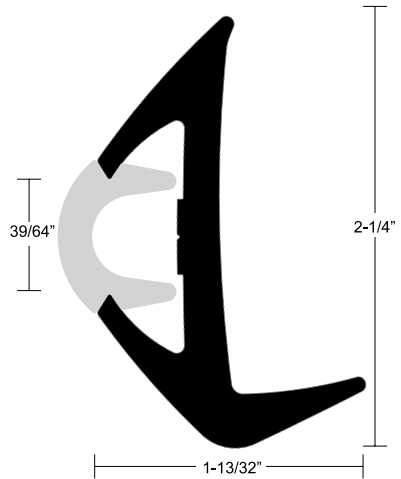

V21-9722

Material: Rigid Vinyl
Insert: S11-4511

Part Number	Color	Length
V21-9722BKA20D	Black	20'

Drilled and countersunk for #8 screws on 8" centers

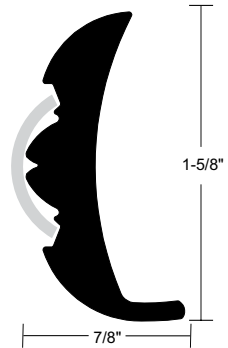

V21-9790

Material: Rigid Vinyl
Insert: S11-4650

Part Number	Color	Length
V21-9790BKA20D	Black	20'

Drilled and countersunk for #10 screws on 6" centers

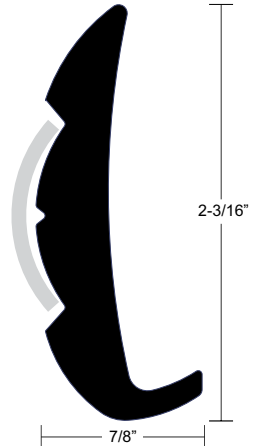

V21-9811

Material: Rigid Vinyl
Insert: V12-9809

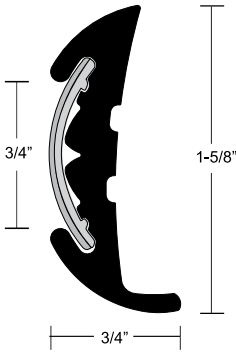

Part Number	Color	Length
V21-9811WHC20D	Frosty White	20'

Drilled and countersunk on 8" centers

V21-9846

Material: Rigid Vinyl
Insert: S11-4650

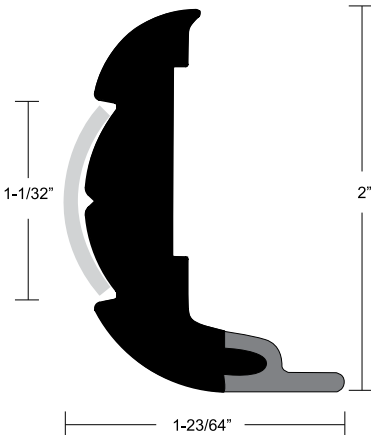

Part Number	Color	Length
V21-9846WHC18D	Frosty White	18'

Drilled and countersunk on 6" centers

V21-9866

Material: Rigid Vinyl
Insert: S11-4511

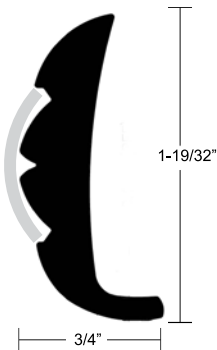

Part Number	Color	Length
V21-9866WHC20D	Frosty White	20'

Drilled and countersunk on 8" centers

TYPE 304 & 316 MARINE GRADE STAINLESS STEEL OVERLAYS

Installed separately or combined with Rigid Vinyl Rub Rail

OVERLAYS

S11-450

Stainless Steel Type 304

Part Number	Finish	Length
S11-450SP12	Polished	12'

Drilled and countersunk for #6 screws on 8" centers



S11-451

Stainless Steel Type 316

Part Number	Finish	Length
S11-451SP12B	Polished	12'

Drilled and countersunk for #10 screws on 6" centers



S11-465

Stainless Steel Type 316

Part Number	Finish	Length
S11-465SP20B	Polished	20'

Drilled and countersunk for #12 screws on 6" centers



S11-467

Stainless Steel Type 316

Part Number	Finish	Length
S11-467SP20B	Polished	20'

Drilled and countersunk for #12 screws on 6" centers



OVERLAYS

S11-469

Stainless Steel Type 316

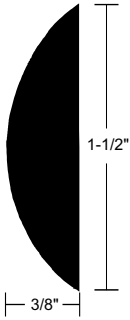

Part Number	Finish	Length
S11-469SP20B	Polished	20'

Drilled and countersunk for #12 screws on 6" centers

S11-471

Stainless Steel Type 316

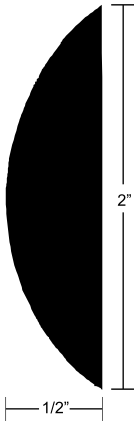

Part Number	Finish	Length
S11-471SP20B	Polished	20'

Drilled and countersunk for #14 screws on 8" centers

S11-4500

Stainless Steel Type 304

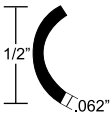

Part Number	Finish	Length
S11-4650P6-1	Polished	6'
S11-4650P12	Polished	12'

Drilled and countersunk for #10 screws on 6" centers

S11-4511

Stainless Steel Type 304

Part Number	Finish	Length
S11-4511P6-1	Polished	12'
S11-4511P12	Polished	12'
S11-4511P16	Polished	16'
S11-4511P16B*	Polished	16'
S11-4511P20	Polished	20'

Drilled and countersunk for #8 screws on 6" centers
*Stainless Steel type 316

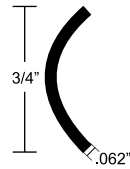

S11-4650

Stainless Steel Type 304

Part Number	Finish	Length
S11-4650P6-1	Polished	6'
S11-4650P16B*	Polished	16'
S11-4650P12	Polished	12'

Drilled and countersunk for #10 screws on 6" centers
*Stainless Steel type 316

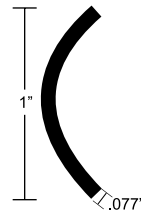

S11-4670

Stainless Steel Type 304

Part Number	Finish	Length
S11-4670P12	Polished	12'

Drilled and countersunk for #10 screws on 6" centers

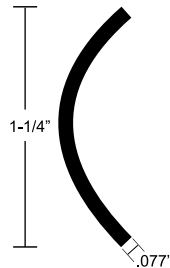

S11-4690

Stainless Steel Type 304

Part Number	Finish	Length
S11-4690P12	Polished	12'

Drilled and countersunk for #10 screws on 6" centers

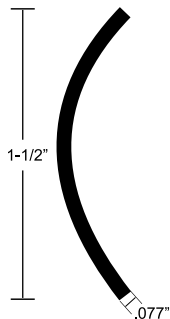

INSERTS

INSERTS

A40-0812

Aluminum Flat Bar Stiffener

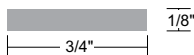

Part Number	Finish	Length
A40-0812AEY10D2	Anodized	10'

Use with flexible rub rail behind insert for smooth installation

V12-0003

Material: Flexible Vinyl



Part Number	Color	Length
V12-0003BKA50-1	Black	50'
V12-0003BKA70-1	Black	70'
V12-0003BKA100-1	Black	100'
V12-0003WHA50-1	Arctic White	50'
V12-0003WHA70-1	Arctic White	70'

V12-0005

Material: Flexible Vinyl



Part Number	Color	Length
V12-0005BKA50-1	Black	50'
V12-0005BKA70-1	Black	70'

V12-0303

Material: Flexible Vinyl

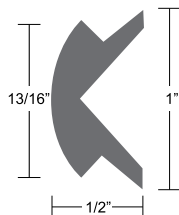

Part Number	Color	Length
V12-0303BKA50-1	Black	50'
V12-0303BKA70-1	Black	70'
V12-0303WHA50-1	Arctic White	50'
V12-0303WHA70-1	Arctic White	70'
V12-0303WHC50-1	Frosty White	50'

V12-0307

Material: Flexible Vinyl

Part Number	Color	Length
V12-0307CP165	Chrome	165'
V12-0307BKA250	Black	250'

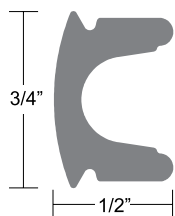

V12-0317

Material: Flexible Vinyl

Part Number	Color	Length
V12-0317BKA50-1	Black	50'
V12-0317WHA50-1	Arctic White	50'

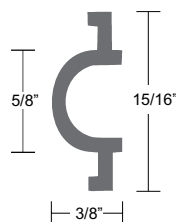

V12-0334

Material: Flexible Vinyl

Part Number	Color	Length
V12-0334BKA50-1	Black	50'

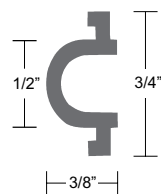

V12-0338

Material: Flexible Vinyl

Part Number	Color	Length
V12-0338BKA50-1	Black	50'
V12-0338BKA70-1	Black	70'

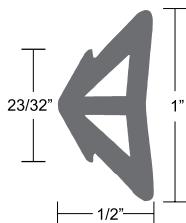

V12-0342

Material: Flexible Vinyl

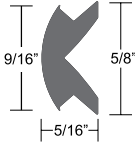

Part Number	Color	Length
V12-0342BKA50-1	Black	50'

V12-0810

Material: Flexible Vinyl



Part Number	Color	Length
V12-0810BKA50-1	Black	50'

V12-1069

Material: Flexible Vinyl
Chrome

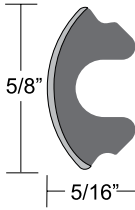

Part Number	Color	Length
V12-1069CP70-1	Chrome	70'
V12-1069CP165	Chrome	165'

V12-4144

Material: Flexible Vinyl

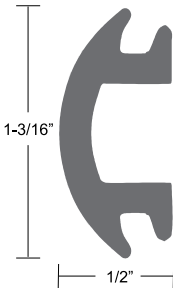

Part Number	Color	Length
V12-4144BKA50-1	Black	50'
V12-4144BKA70-1	Black	70'

V12-4155

Material: Flexible Vinyl

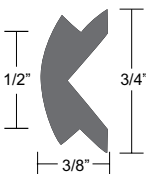

Part Number	Color	Length
V12-4155BKA50-1	Black	50'

V12-5818

Material: Flexible Vinyl

Part Number	Color	Length
V12-5818BKA250	Black	250'

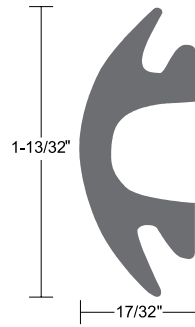

V12-9809

Material: Flexible Vinyl
Chrome

Part Number	Color	Length
V12-9809CP210	Chrome	210'

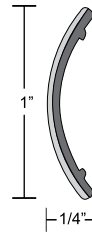

V12-9814

Material: Flexible Vinyl

Part Number	Color	Length
V12-9814BKA250	Black	250'

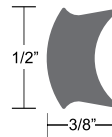

V22-3162

Material: Rigid Vinyl

Part Number	Color	Length
V22-3162BKA12	Black	12'

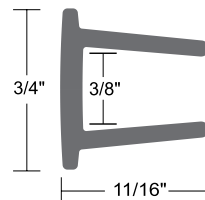

RUB RAIL KITS

KITS



Easy to Install and available in most stores

Kit includes:

Vinyl Rub Rail, Insert (if needed),
End Caps, Screws, Installation Guide,
& Installation DVD (mail-in card)

- Flexible vinyl and semi rigid rub rail kits
- Everything needed in one convenient box
- New easy-carry box
- Grip-and-view packaging for a hands-on look at rub rail

Original and Compatible

TACO supplies the original rub rail to most of the builders listed in this guide. Compatible rub rails are provided for those boats where the builder has more than one supplier or uses a competitor's product. In most cases, the product is virtually identical and interchangeable for all practical purposes.

PART #	HEIGHT	WIDTH	RR COLOR	INSERT COLOR	LENGTH
V11-0809BBK50-2	1-1/16"	11/16"	Black	Black	50'
V11-0809BBK70-2	1-1/16"	11/16"	Black	Black	70'
V11-0809BWK50-2	1-1/16"	11/16"	Black	Arctic White	50'
V11-0899BBK100-2	2-3/8"	1-7/16"	Black	Black	100'
V11-2423BBK50-2	1-7/8"	1-1/16"	Black	Black	50'
V11-2423BBK70-2	1-7/8"	1-1/16"	Black	Black	70'
V11-2423BWK50-2	1-7/8"	1-1/16"	Black	Arctic White	50'
V11-2423BWK70-2	1-7/8"	1-1/16"	Black	Arctic White	70'
V11-3426BBK50-2	1-7/8"	1-3/8"	Black	Black	50'
V11-3426BBK70-2	1-7/8"	1-3/8"	Black	Black	70'
V11-3426BWK50-2	1-7/8"	1-3/8"	Black	Arctic White	50'
V11-3426BWK70-2	1-7/8"	1-3/8"	Black	Arctic White	70'
V11-3426BBK50-2	1-1/4"	15/16"	Black	Black	50'
V11-3426BBK70-2	1-1/4"	15/16"	Black	Black	70'
V11-3447BWK50-2	1-1/4"	15/16"	Black	Arctic White	50'
V11-3447WVK50-2	1-1/4"	15/16"	Arctic White	Arctic White	50'
V11-4135BKA30-3	1-7/8"	3/4"	Black	-	30'
V11-9795BBK50D-2	1-1/2"	3/4"	Black	Black	50'
V11-9811WCM70-2	1-5/8"	3/4"	Arctic White	Chrome	70'

KITS

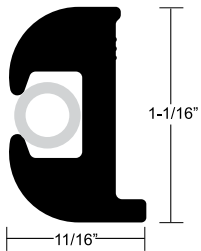

V11-0809

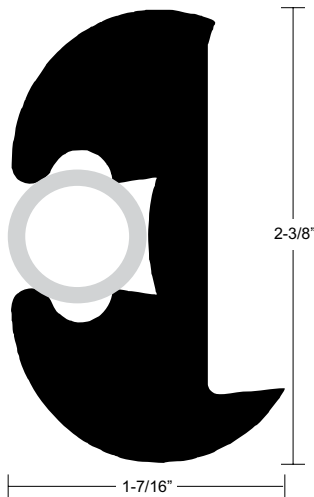

V11-0899

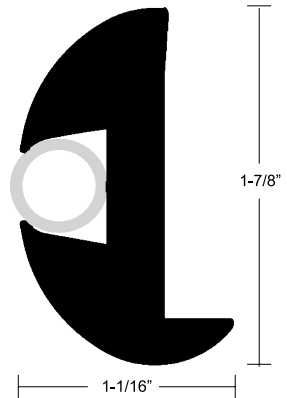

V11-2423

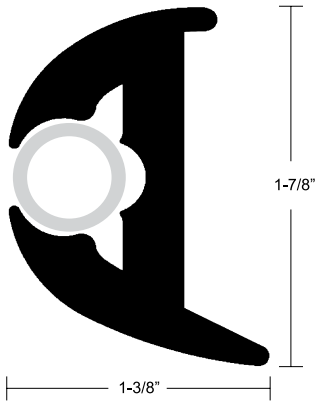

V11-3426

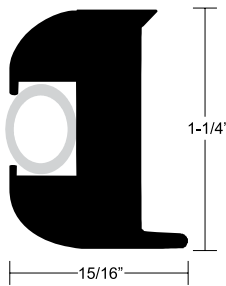

V11-3447

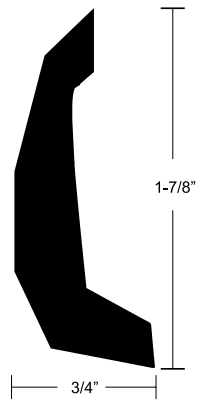

V11-4135

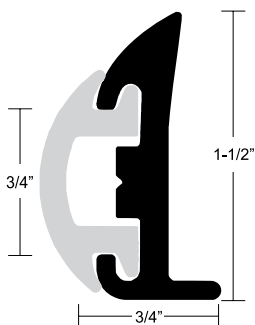

V11-9795

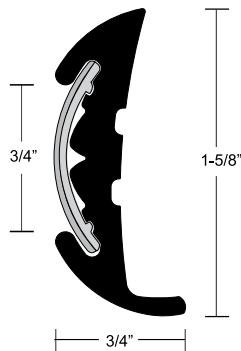

V11-9811

BEFORE YOU BEGIN

BEFORE

- Ensure the length of the rub rail is sufficient for your boat. It is always best to buy an extra 10' for trial and error.
- Make sure to purchase all the materials needed (rub rail, insert, fasteners, end caps, splice caps, etc...) to complete the job.
- Carefully read all the instructions before beginning and/or watch the TACO Rub Rail Installation Video.

ESTIMATING RUB RAIL LENGTH

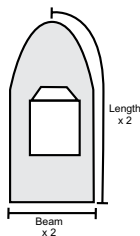

1. Take the length and width (beam) of your boat
2. Add them together and multiply by two
3. The total will give you the minimum length of rub rail required for your boat in feet

RUB RAIL SELECTION TIPS

You can replace your rub rail with a factory replacement style or a completely different look. Regardless of the material originally installed by the builder of your boat, feel free to choose the material and style you desire.

It is easier to install if you remember to choose a rub rail that is at least the same height as the original.

Flexible vinyl rub rail is the easiest to bend and provides a cushioning effect when in use against normal bumps from pilings and docks.

Rigid vinyl, as well as aluminum rub rail with flexible vinyl insert, performs well, lasts long and is easy to install in straight runs.

Rigid vinyl rub rail with stainless steel overlap provides the best protection and the longest useful life.

TOOLS & SUPPLIES NEEDED

- TACO rub rail, insert
- Measuring tape
- Safety goggles
- Two cordless drills (one for a screw driver bit and one for a drill bit)
- Putty knife or scraper
- Caulking gun with silicone sealant or a tube of 3M 5200
- Metal file
- Heat gun (for rigid vinyl rub rail and flexible inserts)
- Garden shears (for cutting flexible vinyl rub rail and inserts) or hacksaw/power saw & cutoff wheel (for cutting stainless steel overlaps)
- Miter box (for metal and rigid vinyl rub rail)
- Rubber mallet
- TACO Rub Rail Installation Video
- Fasteners

BEFORE



TACO Metals and Marine Is Your Choice Because:

- Experience •

We build over 30 years of experience into our products
We are the #1 Rub Rail brand preferred by Boat Builders
We provide the broadest range of Rub Rail solutions

- Service •

You Talk, We Listen...
Our sales team and customer service organization are knowledgeable and responsive & we treat you like family

- Quality Assurance •

We provide the only 5-year warranty in the industry!
We protect your investment with UV coating, color stabilizers and impact modifiers that ensure our Rub Rails hold up to sun and saltwater, protecting your boat against damage

- TACO's Commitment •

Is to "Total Customer Support"
We offer training videos, installation tips and a selection of other helpful information on our website: www.TACOMarine.com

TACO Metals and Marine...Solid Products from a Solid Company

Dealer:

TACO Metals Headquarters
50 N.E. 179th Street
Miami, Florida 33162
Customer Service: 1-800-653-8568
Email: info@TACOMarine.com
Tech Hot Line: 1-800-653-8567
Fax: 1-305-770-2386

